

PocketWizard®
MULTI MAX
TRANSCEIVER

**Owner's
Manual**

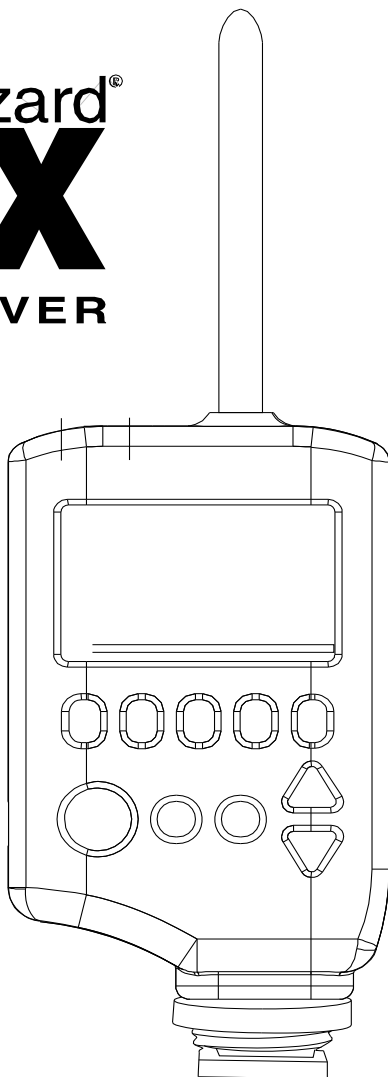

Congratulations on your purchase of the new PocketWizard MultiMAX digital radio triggering system.

The **PocketWizard MultiMAX** is a microprocessor-based radio slave system that uses advanced digital signaling to increase triggering range, reliability, and rejection of radio noise from other sources. Since it utilizes Transceiver technology, it is both a transmitter and a receiver all in one. It is the most innovative and advanced wireless solution in the photographic industry. As a stand-alone unit, the MultiMAX offers precision special effects functions not available in any wireless triggering device. It incorporates integrated Trigger Time Control software, True Trigger Confirmation and Selective Quad-Triggering, all of which offer solutions to photographic challenges that hinder today's photographer's creativity. Unparalleled in features and performance, the Pocket Wizard MultiMAX is more than just a radio slave.

Welcome to Digital Wireless Freedom!

FCC & IC Compliance Information

WARNING: Changes or modifications to this unit not expressly approved by the party responsible for compliance could void the user's authority to operate the equipment.

NOTE: This equipment has been tested and found to comply with the limits for a Class B digital device, pursuant to Part 15 of the FCC Rules. These limits are designed to provide reasonable protection against harmful interference in a residential installation. This equipment generates, uses, and can radiate radio frequency energy and, if not installed and used in accordance with the instructions, may cause harmful interference to radio communications.

However, there is no guarantee that interference will not occur in a particular installation. If this equipment does cause harmful interference to radio or television reception, which can be determined by turning the equipment off and on, the user is encouraged to try to correct the interference by one or more of the following measures:

- Reorient or relocate the receiving antenna.
- Increase the separation between the equipment and receiver.
- Consult the dealer or an experienced radio/TV technician for help.

This device complies with Part 15 of the FCC rules and also with RSS-210 of Industry & Science Canada. Operation is subject to the following two conditions: (1) This device may not cause harmful interference, and (2) this device must accept any interference received, including interference that may cause undesired operation.

Table of Contents

Icons Used in this Manual	8
Features	9
Communication Technology	9
Basic Features	9
Special Features	9
Parts Designation	10
LCD Information	11
Controls	12
Power Switch	12
Keypad	12
PORT 1 / PORT 2	12
Status LED	12
Getting Started	13
Battery Information	13
Inserting Batteries	13
Battery Life	13
Lanyard	14
VELCRO®	14
Care and Maintenance	15
Quick Setup - Basic Radio Slave Operation	16
Basic Setup for Remote Flash	16
Triggering Multiple Flashes With Multiple RECEIVE Units	17
Connecting MultiMAX (set for TRANSMIT mode) to Flash	17
Standard Radio Operation	18
Transceiver Control	18
Channels	18
Compatibility	19
Selective Quad-Triggering (A B C D keys)	20
Classic Channels	21
L Key	21
True Confirmation	22
Radio	22
Optional Flash Confirmation Cable	22

Menu System	24
Navigation	24
LCD Contrast Adjustment	24
Numeric Entry	25
Main Menu	26
A: Advanced Menu	26
B: Basic Settings	26
C: Counter Menu	26
D: Go Advanced	26
D: Go Normal	26
Basic Settings	27
A: Contact Time	27
B: Beep Menu	29
A: Beep on All	29
B: Beep on Trigger	29
C: Beep on Zero / Error	29
D: Beep Disable	29
Counter Menu	30
A: Count Up + Reset	30
B: Count Down + Reset	30
C: Clear / Reset	31
D: Disable	31
L: Load	31
Advanced Menu	32
A: Delay Menu - TRANSMITTER	32
A: Remotes + PORT 2	32
B: Remotes Only	33
C: Rear Curtain	33
A: Delay Menu - RECEIVER	34
A: PORT 1 + PORT 2	34
B: PORT 2	34
C: Equalize	35
B: Intervalometer (Time Lapse Photography)	36
C: Multipop	37
D: SpeedCycler - TRANSMITTER	38
D: Fast Mode - RECEIVER	39

Other Features	39
Keypad Lock	39
High Voltage Protection	39
Relay Mode	40
Software Version Display	40
Applications of Advanced Functions	41
Self-Timer or Cable Release	41
TTL / Auto flash Helper	41
Programmed sequence shooting	42
Recycle Lockout	42
Camera Equalization	43
Lag Time Measurement	44
One Unit Equalization	47
Two Unit Equalization	47
Equalization Adjustments	49
Technical Information	50
Specifications	50
Radio Information	51
Maximum and Minimum Settings	52
Saved Settings	52
Troubleshooting	53
When in doubt !	53
Reset to Default Factory Settings	53
Radio Performance	54
Time Conversion Charts	55
Fractions to Decimal	55
Seconds to Minutes and Hours	55

Icons Used in this Manual



-  Read the information following this icon. It shows important notes about the subject being discussed.



-  Follow this icon for more detailed information on the subject in another section.



-  Find valuable tips and techniques with this icon.

Refer to <http://www.pocketwizard.com/> for updated information.

Features

Communication Technology

- Full Digital Radio Communication
- Microprocessor controlled
- 32 digitally coded channels
- Complex 16 or 24 bit coded signal
- Selective Quad-Trigging

Basic Features

- Built-in hot shoe
- 1/4-20 female mounting thread
- Built-in AC adapter jack (1.8mm)
- Illuminated LCD panel
- Illuminated soft touch keypad
- Extended battery life
- Sync speeds up to 1/250 with focal plane shutter, 1/500 with leaf shutter
- Fast Mode syncs up to 1/1 000 with compatible cameras and flashes
- Adjustable contact closure time
- Compatible with PocketWizard Classic, Plus, and MAX
- Protects cameras from high sync voltage
- Customizable audible beep settings
- Weighs less than 5.5 ounces with batteries

Special Features

- Transceiver Technology
- True Confirmation
 - Quad-Trigging Confirmation on all four zones
 - Flash Confirmation with Optional Cable on all four zones
- Trigger Time Controller Software
 - Rear Curtain Sync
 - Precision Delays
 - Intervalometer
 - Multipop
 - Lag Time Measurement
 - Multiple Camera Equalization
 - SpeedCycler
 - Relay Mode

Parts Designation



LCD Information

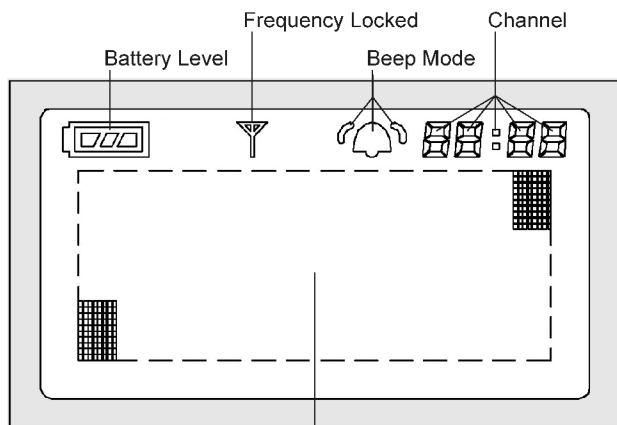

Primary Display Area for Main Screen, Menus, Numeric Entry, etc.

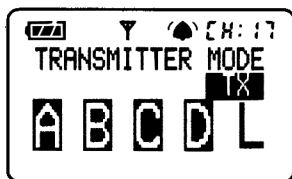

TRANSMITTER
Default Power On Screen

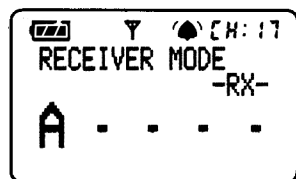

RECEIVER
Default Power On Screen



MAIN MENU
Default Screen

Controls

Power Switch

- **TRANSMIT** Unit is powered on in TRANSMITTER (TX) mode
- **RECEIVE** Unit is powered on in RECEIVER (RX) mode
- **OFF** Unit is powered OFF



Power Switch

Keypad

- **A B C D L** Selects Quad-T triggering Zones and Local. Also used in menu navigation and numeric entry
- **TEST** Triggers MultiMAX. Press to test operation or to trigger remote units and/or attached cameras/flashes (Back Light) Illuminates LCD and keypad. Hold down for key lock
-  (Back Light) Illuminates LCD and keypad. Hold down for key lock
- ***/MENU** Enters or exits menu system. Stores numbers in numeric entry
- **▲▼** (Up / Down) Selects channels. Also used in numeric entry

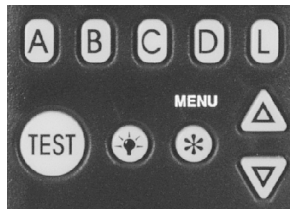

Keypad

PORT 1 / PORT 2

- **CAMERA / PORT 1 =**
 - Input from camera sync terminal, external trigger button, Flash Confirmation Cable, or other device
 - Output to camera motor drive, flash, or other device
- **FLASH / PORT 2 =**
 - Output to flash, camera motor drive, or other device

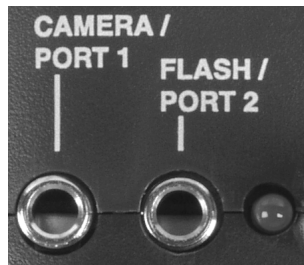

PORT 1 / PORT 2 / Status LED

Status LED

Displays the following information:

- Blinking every few seconds = power on, ready for trigger
- Blinking in sync with trigger = normal triggering
- Steady =
 - continuously triggered from radio, hot shoe, or PORT 1
 - performing delay or contact time
- Slow blink every second = performing Intervalometer or Multi-pop function
- Dark = power off or poor battery condition

Getting Started

Battery Information

The MultiMAX requires two AA size (IEC: LR6) batteries. The MultiMAX will operate normally with Nickel Metal Hydride (NiMH), Lithium Ion (Li), Nickel Cadmium (NiCad) and Alkaline batteries.

Alkaline batteries are recommended.

Inserting Batteries

1. Set power switch to OFF position
2. Open battery door
3. Insert fresh batteries noting correct orientation as displayed in battery compartment
4. Close battery door
5. Use unit normally

⚠ Erratic unit behavior or malfunction may occur if batteries are inserted while the power switch is set to either RECEIVE or TRANSMIT. Always make sure the power switch is set to OFF before changing or inserting batteries.



Battery Compartment

Battery Life

The MultiMAX displays remaining battery life with a 3 segment battery icon in the upper left corner of the LCD:

3 segments displayed = batteries are fresh/new

2 segments displayed = batteries are good

1 segment displayed = replace batteries soon

0 segments displayed = install fresh/new batteries immediately



Battery Icon

With one set of standard Alkaline batteries the MultiMAX will operate for approximately 150 hours. This time may vary depending on temperature, battery type, and the quality of batteries used. Extensive use of back light, speaker, or extended trigger contact times will consume the batteries at a faster rate.

The MultiMAX continually regulates the battery power which gives excellent performance throughout the life of the batteries. The unit will continue to function normally until the batteries are nearly exhausted.

👁 The MultiMAX voltage regulation is very efficient. There is only a small benefit when using Lithium batteries. Lithium batteries are designed for the quick burst high current draw found in cameras and portable flash devices. Expect only a 10 - 20% longer battery life (approximate) over Alkaline batteries when using Lithium batteries.

🔧 Examine batteries frequently to prevent damage from leaking battery acid. Remove batteries from MultiMAX units in the following circumstances to avoid damage from leaking:

- If unit will not be used for a period longer than 2 weeks
- During shipping or air travel
- In high heat environments

Lanyard

A lanyard is included for hanging each unit conveniently on a light stand, tripod, belt, or other location. If desired, attach the included lanyard to the lanyard loop.

VELCRO® Brand Fasteners

VELCRO® adhesive hook and loop fasteners are included with the MultiMAX to provide a convenient means of mounting the unit in a variety of places.

Attach as desired being careful to not obscure controls or function. Recommended mounting locations:

- Right side of the unit
- Left side of unit
- Below 1/4-20 tripod mount

👁 The battery door is not a recommended mounting location.

Care and Maintenance

To ensure continued reliability, please follow these guidelines:

- Do not subject units to high mechanical shock (do not drop!)
- Keep unit dry. Do not immerse in any liquid
- Set power switch to OFF when not in use
- Remove used batteries promptly
- Remove batteries for travel or extended storage
- Clean with soft dry cloth
- Operating temperature: above -15° (5° F) and below 50° C (120° F)
- Storage temperature without batteries:
 - above -30° C (-22° F)
 - below $+85^{\circ}$ C (185° F).

Quick Setup - Basic Radio Slave Operation

Basic Setup for Remote Flash

- 👁 Turn off all equipment before installing batteries or making connections!
1. Install 2 AA batteries in each MultiMAX
 2. Connect camera to first MultiMAX:
 - a. Slide unit into camera hot shoe
- or -
 - b. Use sync cable (included) to connect camera's PC terminal to CAMERA / PORT 1
 3. Connect flash to second MultiMAX
 - a. Use flash cable to connect flash unit's sync terminal to FLASH / PORT 2
 4. Turn both MultiMAX units on
 - a. Set power switch on MultiMAX attached to camera to TRANSMIT mode
 - b. Set power switch on MultiMAX attached to flash to RECEIVE mode
 5. Set both MultiMAX units to same channel and Quad-Triggering zone
 - a. Use ▲▼ to set channel (default is CH: 17)
 - b. Use **A B C D L** to select Quad-Triggering zones
(default is TRANSMIT = **A B C D L**, RECEIVE = **A**)
 6. Turn camera and flash on
 7. Press **TEST** button on MultiMAX (set for TRANSMIT mode) and release. Confirm remote flash triggers.

You're all set! Use the camera normally.

Triggering Multiple Flashes With Multiple RECEIVE Units

Multiple remote flash units may be triggered in sync with each other.

1. Install batteries in each additional MultiMAX unit
2. Use flash cable to connect each additional flash unit's sync terminal to FLASH / PORT 2
3. Set power switch on each additional MultiMAX unit to RECEIVE mode
4. Set all MultiMAX units to same channel as TRANSMIT unit

You're all set! Use the camera normally.

Connecting MultiMAX (set for TRANSMIT mode) to Flash

A flash can be connected to a MultiMAX (set for TRANSMIT mode). It will trigger in sync with the remote flash units. This flash is called the local flash and is usually mounted on a camera bracket.

1. Use a flash cable to connect the flash unit's sync terminal to FLASH / PORT 2 of the MultiMAX (set for TRANSMIT mode)
2. Use the **L** key to enable or disable the Local flash

You're all set! Use the camera normally.

 Using a local flash this way protects the camera from high voltages. See the **Specifications** section, Page 50, for more information.

Standard Radio Operation

Transceiver Control

The MultiMAX operates as either a transmitter or a receiver. To use the MultiMAX as a Transmitter (sending device) set the power switch to TRANSMIT. To use the MultiMAX as a Receiver set the power switch to RECEIVE.

 There is a special mode that enables a MultiMAX to automatically switch from RECEIVE to TRANSMIT then back to RECEIVE while triggering a remote camera. Read the **Relay Mode** section, Page 40, for more information.

Channels

The MultiMAX is a 32 channel digital radio slave. Each MultiMAX channel represents a digital code transmitted on specific PocketWizard radio frequencies. This enables many photographers to work in the same area. It also enables a photographer to control multiple remote devices (cameras, flash units, etc).

A MultiMAX (set for TRANSMIT mode) will trigger any number of MultiMAX units (set for RECEIVE mode) set to the same channel. Units set to different channels will not interfere with each other.

From the main screen press the ▲▼ keys to change channels.

Some MultiMAX features are only available on higher channels. Refer to the table below for features / channels availability:

Features	Channels 1 - 16	Channels 17 - 32
Digital Radio Signal	X	X
Delay including Rear Curtain Sync	X	X
Intervalometer	X	X
Multipop	X	X
Relay Mode	X	X
Selective Quad-Triggering		X
Confirmation (Radio and Flash)		X
Fast Mode		X
SpeedCycler		X

Compatibility

MultiMAX channels are compatible with all PocketWizard radio slave products per the table below:

Digital Radio Model	MultiMAX Compatible Channels
PocketWizard 10 Channel Classic	1-10
PocketWizard 16 Channel Classic	1-16
PocketWizard Plus	1-4
PocketWizard MAX	1-16 17-32 Quad-Triggering or Fast Mode
Sekonic Digital Radio Transmitter Module RT-32 (L358, L608, L608 CINE)	1-16 17-32 Quad-Triggering
Sekonic Digital Radio Receiver RR-4	1-4
Sekonic Digital Radio Receiver RR-32	1-16 17-32 Quad-Triggering or Fast Mode
Calumet Radio Equipped Turbo Filter	1-9

The digital radio design of the MultiMAX will enable it to be fully compatible with future PocketWizard products.

Selective Quad-Triggering (A B C D keys)

This powerful feature is used to individually control up to 4 sets of MultiMAX units (set for RECEIVE mode) on the same channel. Each keypad letter, **A B C D** refers to an individual zone. Each zone can be independently selected or deselected from a MultiMAX (set for TRANSMIT mode).

Follow the steps below to test Quad-Triggering:

1. Set one MultiMAX to TRANSMIT mode
2. Set up to 4 MultiMAX units to RECEIVE mode (same channel as TRANSMIT unit)
3. Using the **A B C D L** keys set each RECEIVE unit to a different zone
4. On the TRANSMIT unit use the **A B C D L** keys to select which zones will trigger. The zone is selected when the letter is displayed on the LCD screen. The zone is deselected when a dot appears where the letter would be displayed.
5. Press the TEST key on the MultiMAX (set for TRANSMIT mode) unit to trigger the selected zones

Any number of MultiMAX units (set for RECEIVE mode) may be set to the same channel and zone, and will trigger simultaneously. Selective Quad-Triggering is only available on channels 17 and higher.

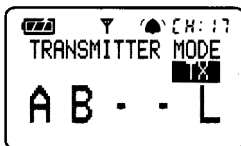

TRANSMIT unit
Channel: 17
Zones: A, B, and Local

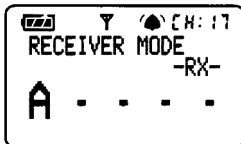

RECEIVE unit
Channel: 17, Zone: A

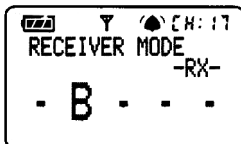

RECEIVE unit
Channel: 17, Zone: B

Classic Channels

Classic channels are compatible with early PocketWizard models and the PocketWizard Plus. Selective Quad-Triggering is only available in channels 17 through 32. In channels 1 through 16 the display will show CLASSIC CHANNEL and zones **A B C D** do not appear. The **A** key simply toggles the remote receivers on or off and is displayed on the main screen as **R**. It is not possible to toggle both the remote (**A** key) and the local flash (**L** key) off at the same time when using a CLASSIC CHANNEL. Operation on these channels is identical to the function of the LOCAL / BOTH / REMOTE switch found on PocketWizard Plus and Classic Transmitters.

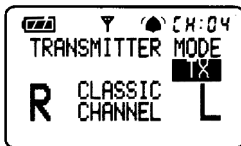

TRANSMIT unit set to
CLASSIC CHANNEL 4
Remote and Local selected

L Key

On any channel the **L** key toggles the local flash on or off in a MultiMAX (set for TRANSMIT mode).

☞ See the **Connecting MultiMAX (set for TRANSMIT mode) to Flash** section, Page 17, for more information.

☞ The **L** key toggles **Relay Mode** when using a MultiMAX (set for RECEIVE mode). See the **Relay Mode** section, Page 40, for more information.

True Confirmation

Because the MultiMAX is a true transceiver it automatically confirms triggering. It can perform this on two levels: it confirms the round trip radio signal and can confirm actual flash sync with an optional flash confirmation cable. It does this for all Quad-Triggering zones on every trigger. Confirmation is indicated visually on the main screen and audibly using beep modes.

 For audible confirmation settings see the **Beep Menu** section, Page 29.

Radio

Radio confirmation is displayed on TRANSMIT units in the **A B C D** area of the LCD. An inverted letter shows an error. A normal letter shows confirmation.

During normal operation the display will show selected and active **A B C D** zones not inverted. Confirmation will occur on every trigger and only in the event of an error will the zone letters invert.

Optional Flash Confirmation Cable

Using the flash confirmation cable the MultiMAX can confirm flash sync for all four zones on every trigger.

1. Attach flash confirmation cable to PORT 1 for each MultiMAX (set for RECEIVE mode)
2. Locate the sensor so that it can only see the flash from the correct flash unit
3. Press the TEST button on a MultiMAX (set for TRANSMIT mode) to test flash confirmation. Correct flash confirmation is displayed on the main screen with a flash icon to the right of each zone performing flash confirmation. In the event of an error (either no flash was detected or the radio link was incomplete) the zone letter and the flash icon will invert

A MultiMAX (set for TRANSMIT mode) will look for RECEIVE units and confirm the radio link after each of these operations:

- Every trigger
- Power on or switch from RECEIVE to TRANSMIT
- Channel change
- Zone change (including **L**)
- Exiting the menu system

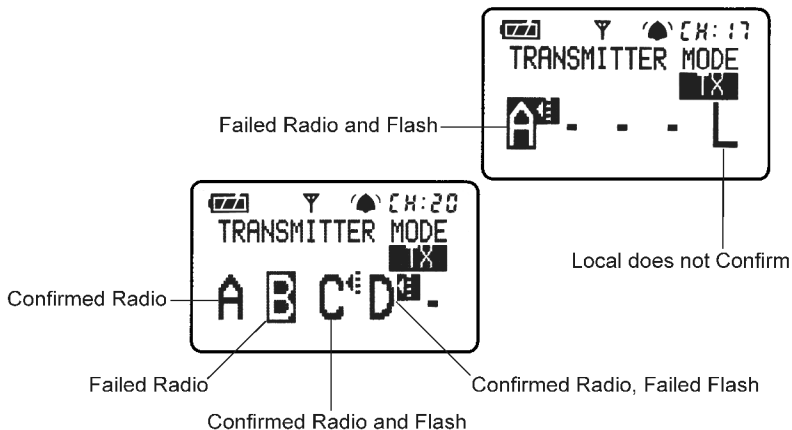

👁 Confirmation can only be performed using MultiMAX units on channels 17 and higher. PocketWizard Plus, Classic, and the original MAX do not perform confirmation.

👁 True Confirmation is designed to work with one MultiMAX (set for RECEIVE mode) per zone. Multiple RECEIVE units set to the same channel and zone will not individually confirm and may cause incorrect confirmation errors. If multiple MultiMAX units (set for RECEIVE mode) on the same channel and zone are a mix of flash and non-flash confirmation units then accurate flash confirmation will not be reported.

The following table shows how confirmation works in different modes:

MultiMAX Mode	Radio and Flash Confirmation
A RECEIVE unit using Selective Quad-Triggering	Provides normal radio and / or flash confirmation
A RECEIVE unit set to a Delay mode	Will not provide confirmation
A RECEIVE unit set to FAST MODE	Confirms on zone A only
A RECEIVE unit set to Intervalometer or Multipop	Provides radio confirmation before the first interval only

Menu System

Navigation

Many functions of the MultiMAX are accessed through easy-to-navigate menus.

Press ***/MENU** to enter the menu system. Menu items are selected by using the **A B C D L** keys.

While within the menus the ***/MENU** key performs two functions:

- If a menu is displayed, pressing ***/MENU** returns you to the main screen
- If a numeric entry is displayed, pressing ***/MENU** stores the displayed number in memory and proceeds to either the next input screen or the main screen depending on mode

 In the next chapters many of the headings will be followed by ***/MENU** and some letter combinations. These are quick references for the keys to press to get to that function fast.

LCD Contrast Adjustment

While in any menu, use the **▲▼** keys to adjust the display contrast.

Numeric Entry

Several menu items require a number or value to be entered. Numeric entry is performed with **A B C D** and **▲▼** keys. The **A B C D** keys each select and add 1 to a specific digit as follows:

- A – selects and adds 1 to the 4th digit from the right
- B – selects and adds 1 to the 3rd digit from the right
- C – selects and adds 1 to the 2nd digit from the right
- D – selects and adds 1 to the rightmost digit

Once a digit has been selected, use the **▲▼** keys to adjust the number. Press and hold **▲▼** for faster entry.

Numbers entered in this fashion are saved when the ***/MENU** key is pressed and will remain saved even after power is turned off. If the unit is powered off while a numeric entry screen is displayed, the displayed number will not be saved.

 The **L** key is not used for numeric entry. It is used for Lag Time Measurement and is only available in certain Delay modes. See the section on **Lag Time Measurement**, Page 44, for more information.

 To quickly get to the lowest setting press and release the A key once (selects the highest digit) then press and hold the **▼** key.

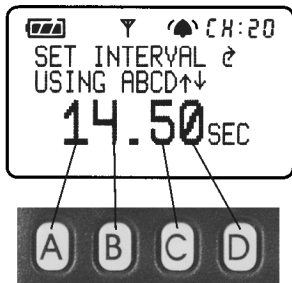

EXAMPLE 1
Numeric Entry



EXAMPLE 2
Numeric Entry

Main Menu

From the main screen press ***/MENU** to enter the Main Menu. Press a letter to either proceed to another menu or perform a function per the list below.



A: Advanced Menu – ***/MENU A**

Press **A** to enter the Advanced Menu. The Advanced Menu contains Delay modes (including Rear Curtain Sync), Intervalometer, Multipop, and SpeedCycler modes.

Main Menu
Go Advanced

B: Basic Settings – ***/MENU B**

Press **B** to enter the Basic Settings menu. It contains Contact time and Beep menu.

C: Counter Menu – ***/MENU C**

Press **C** to enter the Trigger Counter Menu which contains Counter direction, and other counter functions: Reset / Clear, Disable, and Load.

D: Go Advanced – ***/MENU D**

D: Go Normal – ***/MENU D**

Press **D** to toggle between the last Advanced mode used and Normal mode.



This function enables a quick return to standard or normal operation from an advanced function. The settings of the advanced function are saved.

Main Menu
Go Normal

 Go Normal is a quick way to get to standard radio slave operation after using advanced functions and menus. Use this function to “turn off” an advanced mode and use the MultiMAX as a radio slave only.

Basic Settings

Press ***/MENU B** to enter the Basic Settings menu. Press the corresponding letter for the setting you wish to adjust.



A: Contact Time – ***/MENU B A**

Basic Settings Menu

Contact time is the length of time that CAMERA / PORT 1 or FLASH /PORT 2 outputs remain contacted. The default Contact Time of 0.12 is enough to trigger most camera motor drives and flashes. Many photographers will never need to adjust this number.

👁 Contact time is how long the internal switch is held closed. For example, if the contact time is set to 3 seconds and a camera motor drive is attached to a MultiMAX, when the MultiMAX triggers the camera it will hold the contact for 3 seconds. This is identical to pressing and holding the camera's trigger button for 3 seconds. The contact time starts as soon as any input is complete. Input can be from any of the following sources: **TEST** button is pressed, hot shoe is triggered, or radio trigger is received.

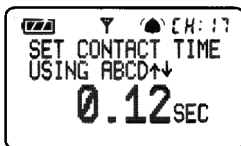

Set Contact Time Screen

👁 Contact time is NOT the length of time a MultiMAX (set for TRANSMIT mode) will send a radio triggering signal. Contact time affects PORT 1 and PORT 2 only and does not affect radio trigger transmission. Pressing and holding **TEST** on a MultiMAX (set for TRANSMIT mode) will continuously send the radio trigger signal and hold the contact on a MultiMAX (set for RECEIVE) as well as the TRANSMIT unit. When the **TEST** button is released each unit's contact time will then begin.

👁 Additional triggers occurring during contact time are ignored. The default contact time is 0.12 seconds which triggers all cameras and flash units. A shorter contact time allows for more triggers per second but may not trigger some motor driven cameras because it's too fast. The default setting of 0.12 allows for 8 triggers per second. The maximum of 30 triggers per second can be obtained by setting contact time to 0.01 seconds.

For triggering remote cameras, a longer contact time allows for continuous repeatable motor drive triggering (example: 5 frame bursts every trigger). It also allows for controlled bulb exposure.

- **Example of Burst Shooting:** If a remote camera is capable of firing 3 frames per second in continuous motor drive, then a contact time of 1 second will always result in this remote camera triggering for 3 exposures
- **Example of Bulb / Shutter Held Open:** Set the contact time for the desired bulb exposure time and set the camera to bulb or B mode. When triggered the shutter will remain open for the contact time

For triggering a remote flash contact time can act as a flash recycle lockout.

- **Example of Flash Recycle Lockout:** To guarantee that a flash cannot be triggered faster than its recycle time, set the contact time to be just longer than the recycle time

 This method of flash recycle lockout does not work with all flash systems as some will not recycle while the sync contact is held. See **Recycle Lockout** in the **Applications of Advanced Functions** section, Page 42, for another recycle lockout method.

 If you are using **Intervalometer** or **Multipop** modes, read these sections, Page 36 and Page 37, for information on these modes and how they interact with Contact Time.

B: Beep Menu – */MENU B B

This menu controls the beep functions of a MultiMAX. Press the corresponding letter to set the desired function of the built-in speaker.

A: Beep on All – */MENU B B A

MultiMAX will beep on all triggering, confirmation errors, and zero counts as indicated below as well as on any key pressed.

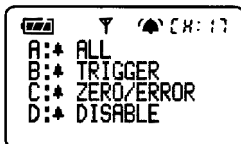

Beep Menu

B: Beep on Trigger – */MENU B B B

Unit will beep when triggered by **TEST** button, PORT 1, a Radio Trigger, or the Hot Shoe in the following manner:

Beep Characteristic	Indicates
Single Short Beep	Indicates Proper Confirmation
Single Long Beep	Indicates Trigger Error
Single Very Short Beep	When any Key is pressed

C: Beep on Zero / Error – */MENU B B C

The MultiMAX unit will not beep on normal triggering. The MultiMAX will beep only when the counter reaches zero and on confirmation errors in the following manner:

Beep Characteristic	Indicates
Single Long Beep	Indicates Trigger Confirmation error or remote MultiMAX (unit set for RECEIVE mode) has reached zero count
Double Long Beep	Indicates MultiMAX has reached zero count
Single Short Beep	Any Key is pressed except TEST

👉 A MultiMAX (set for RECEIVE mode) set to Beep on Zero / Error or set to Beep on All will indicate a confirmation error if the unit is also set to count down and the counter reaches zero. See the **Counter** section, Page 30, for more information.

D: Beep Disable – */MENU B B

Turns off all beep functions. Unit will not beep.

Counter Menu

Press ***/MENU C** enter the Counter Menu. This menu controls the counter functions of the MultiMAX. The counter can show the total number of triggers. It can also count up or down from a set value. Count is incremented on every trigger from any source: PORT 1, **TEST** button, Hot Shoe, or Radio Trigger.

A: Count Up + Reset – ***/MENU C A**

Count is set to COUNT UP (example: 0,1,2,3,...) and the counter is reset to 0. The main screen will display COUNT **0**: 0.

B: Count Down + Reset – ***/MENU C B**

Count direction is set to DOWN (example: 10,9,8,7,...) and the counter is reset to the load counter value. The main screen will display COUNT **0**: XXXX (XXXX = load value)

 The count down function could be used to indicate the number of remaining frames for a remote camera.

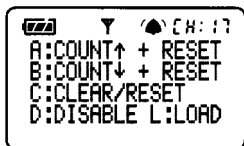

Counter Menu

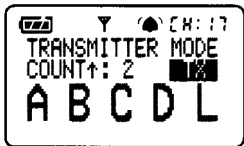

TRANSMIT unit set to
Count Up

C: Clear / Reset – */MENU C C

Count direction is not changed. Counter is reset to 0 if count direction is set to up, or the counter is reset to the load value if count direction is set to down. If the counter is disabled, then this function will enable the counter using the last count direction set. The Counter is cleared and reset in this fashion when the unit is powered down.

👉 Use */C C as an easy to remember quick key combination for fast counter reset.

D: Disable – */MENU C D

Counter is disabled and is not displayed on the main screen. While disabled the counter does not count.

L: Load – */MENU C L

Enables custom setting of the load count value (desired number to start the count from, which is then loaded into the MultiMAX computer memory). The default value is 36. Maximum value for the counter is 9999.

Loading a counter value while the counter is enabled will set the main screen count to that value and counting will continue in the last direction set (UP or DOWN).

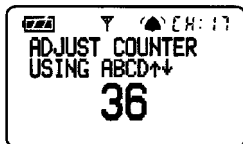

Load Counter Screen

👁️ The load counter value is shared with the **Intervalometer** and **Multipop** functions. Setting a count in either of these functions also sets the load count value for normal counter operation.

Advanced Menu

Press ***/MENU A** to enter the Advanced Menu. This menu contains the advanced functions of the MultiMAX. Precision timing and sequencing operations are available in this menu.

 Press ***/MENU D** to cancel advanced functions and return to normal mode. See the section on **D:Go Advanced** and **D:Go Normal**, Page 26..

A: Delay Menu - TRANSMITTER – ***/MENU A A**

Enters the delay menu for MultiMAX units (set for TRANSMIT mode).

 Delay menus, with the exception of Rear Curtain, require numeric entry. See the **Numeric Entry** section, Page 25.

 All delay screens (numeric entry or rear curtain) are instantly active and triggering can occur while these screens are displayed. A value displayed on these screens will be used immediately on trigger. This is useful for fine tuning a delay or adjusting rear curtain sync.

 The maximum delay is 6.4 seconds. For longer delays see the **Intervalometer** section, Page 36.

A: Remotes + PORT 2 – ***/MENU A A A**

Enters the numeric entry screen. Delays the remote units and PORT 2. Remote units and PORT 2 will fire at the same time after the displayed delay. PORT 2 will remain contacted for the set contact time. On the main display a small letter **D** will appear over the right of the large **L** to show that the Local output (PORT 2) will be delayed. Pressing **L** will toggle the Local output (PORT 2) on and off, but the small **D** will remain.



RECEIVE unit
Advanced Menu



TRANSMIT unit
Advanced Menu



TRANSMIT unit
Delay Menu



TRANSMIT unit
Remotes + PORT 2 delayed

B: Remotes Only – ***/MENU A A B**

Enters the numeric entry screen. Delays the Radio remote units only. PORT 2 will trigger immediately. Remote units will trigger after the displayed delay. If the contact time for the MultiMAX (set for TRANSMIT mode) is longer than the delay, PORT 2 will remain contacted for the delay time rather than the contact time.

C: Rear Curtain – ***/MENU A A C**

Enters the Rear Curtain screen. Use this mode to trigger the flash at the end of an exposure rather than at the beginning. In this mode both the Radio remote trigger and PORT 2 are delayed.

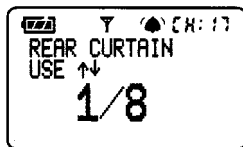

Rear Curtain Screen

Use the ▲▼ keys to set the rear curtain sync time equal to the camera's shutter speed. Common rear curtain sync times are available per the table below:

Rear Curtain Sync Time	Decimal Equivalent	Actual Delay Used
1/1	1 second	0.98 seconds
½	0.5 seconds	0.49 seconds
¼	0.25 seconds	0.24 seconds
1/8	0.125 seconds	0.119 seconds
1/15	0.0667 seconds	0.062 seconds
1/30	0.0333 seconds	0.029 seconds
1/60	0.0167 seconds	0.014 seconds

 For rear curtain sync times other than the ones displayed above, or for fine tuning rear curtain times for your specific equipment, press ***/MENU** to return to the main screen. Press ***/MENU A A A** (see the section A:Delay Remotes + PORT 2, Page 32) and adjust the delay number as needed.

A: Delay Menu - RECEIVER – */MENU A A

Enters the delay menu for a MultiMAX (set for RECEIVE mode). Each RECEIVE unit can have its own delay for sequences or for synchronization. To easily delay all RECEIVE units the same amount, use the Transmitter's delay.

👁️ RECEIVE units set to delay do not perform confirmation.



RECEIVE unit
Delay Menu

A: PORT 1 + PORT 2 – */MENU A A A

Enters the numeric entry screen. PORT 1 and PORT 2 are delayed the same amount and trigger simultaneously after the set delay time. Both ports remain contacted for the set contact time. Triggers can come from either the **TEST** key or a radio trigger from any PocketWizard Transmitter. On the main display a small letter **D** will appear to denote that PORT 2 will be delayed.

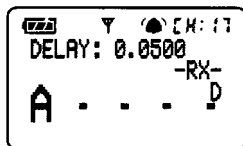

RECEIVE unit
PORT 1 + PORT 2 delayed

👉 Pressing **L** will toggle **Relay Mode** on and off but PORT 2 will still trigger after the set delay. See the **Relay Mode** section, Page 40, for more information.

B: PORT 2 – */MENU A A B

Enters the numeric entry screen. PORT 1 triggers immediately upon pressing **TEST** key or Radio Trigger. PORT 1 contact is held for the set delay time. PORT 2 triggers after the set delay time and contact is held for the set contact time.

C: Equalize – ***/MENU A A C**

Equalize Mode is a specialized delay mode for synchronizing multiple cameras to one flash. This mode is designed to work with shutter speeds up to 1/125 on some cameras, but there are many factors that could affect operation.

 Read the **Camera Equalization** section, Page 43 , before continuing.

Equalize mode is designed to be used with at least 3 MultiMAX units (set in RECEIVE mode). Two or more MultiMAX units will be attached to cameras and one MultiMAX will be attached to a flash unit. A MultiMAX or other PocketWizard TRANSMITTER will be used to trigger the system.

1. Place a MultiMAX (set to RECEIVE mode) on the camera hot shoe or attach cable from camera's PC terminal to PORT 1
2. Attach cable from PORT 2 to camera's motor drive. If available, use a Pre-Trigger cable (more information in the **Camera Equalization** section).
3. If the Equalize Screen is not displayed then press ***/MENU A A A** from the main screen to enter Equalize Mode. This enters the numeric entry screen and 0.1500 seconds are displayed
4. Press the **L** key. The camera should trigger and a lag time (camera triggering delay) will be measured and displayed. Press **L** every few seconds for 5 to 15 exposures until you see the fastest lag time (lowest number displayed) for the camera
5. Press the ***/MENU** key to return to the main screen. A delay value will be displayed. This number is a calculated number and will differ from the lag time you saw on the previous screen
6. Repeat steps 1 through 5 for each camera to be equalized. Use one MultiMAX (set for RECEIVE mode) per camera.
7. Attach a MultiMAX (set for RECEIVE mode) to a flash unit.
8. From the main screen press ***/MENU A A C**. When the numeric entry screen appears with 0.1500 displayed, simply press ***/MENU** to return to the main screen. Do not adjust the number and do NOT press **L**. The main screen will show a delay of 0.1500
9. Press **TEST** on any PocketWizard Transmitter to trigger this equalized system



Equalize Screen

B: Intervalometer (Time Lapse Photography) – */MENU A B

Enters the Intervalometer interval setting screen. Intervalometer can be used to trigger a flash or a camera at a set interval (time gap between triggers) for a set number of triggers. The interval time is set in one second increments up to 64000 seconds for a maximum of 9999 triggers.

1. From the main screen press ***/MENU A B** to enter the numeric entry screen
2. Enter the interval or time gap between triggers
3. Press ***/MENU** to proceed to the next screen
4. Enter the count or number of triggers
5. Press ***/MENU** to return to the main screen. The interval will be displayed, and the count will show the number of triggers to be executed.
6. Press **TEST** or trigger MultiMAX via Radio to begin intervalometer function

Intervalometer has two modes of operation depending on which PORT is used:

- PORT 1 = first trigger takes place AFTER first interval
- PORT 2 = first trigger takes place BEFORE first interval

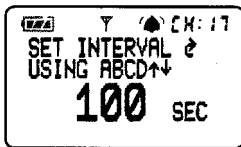

Intervalometer Mode
Set Interval Screen

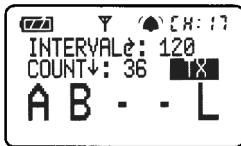

TRANSMIT unit
120 second Interval
36 trigger Count

 A MultiMAX (set for TRANSMIT mode) does not send interval radio triggers. The MultiMAX (set for TRANSMIT mode) will send out a single radio trigger pulse at the beginning of the first interval only. It will continue to trigger devices attached to its PORTs, but it will not send a radio trigger for any more intervals. For remote interval operation, use interval mode on a RECEIVE unit. Each MultiMAX (set for RECEIVE mode) may have a unique interval setting or can be used with equal settings. Interval and count entry screens are instantly active

The Set Interval and Adjust Counter screens are instantly active. While the Set Interval screen is displayed a change of interval will be immediately executed upon trigger either from the **TEST** key or Radio trigger. The count used will be the last count set. If the Adjust Counter screen is displayed a change of count will be immediately executed upon trigger using the last interval set.

 Intervalometer can be interrupted by pressing and holding the ***/MENU** key.

👉 For delays longer than the 6.4 seconds (maximum available in delay modes) use Intervalometer or Multipop mode. Set the interval to the desired delay. Set the count to 1. Attach your camera to PORT 1 and trigger the MultiMAX . The camera will trigger after the set interval.

👁️ Contact time affects Intervalometer mode. If the contact time is less than one second then Intervalometer will function normally. If the contact time is longer than 1 second then the set interval increases per this formula: Contact Time PLUS Interval time MINUS 1 second. Example: If the Contact Time is set to 3 seconds and the Interval is set to 5 seconds, the actual interval will be 7 seconds (3+5-1=7).

👉 When using Intervalometer and Relay Mode together, a MultiMAX (set for RECEIVE mode) will switch to Transmit mode and send a Radio trigger after the last interval. See the **Relay Mode** section, Page 40, for more information

C: Multipop – */MENU A C

Enters the Multipop interval setting screen. This mode is for triggering a flash multiple times from one trigger. It can be used during one long exposure to increase depth of field or for special effect sequencing. The interval setting is normally used to set a safe flash recycling time, while the count is set to the number of flashes or “pops” desired.

Multipop is identical in function to Intervalometer with one exception: the multipop interval range has finer resolution; from 0.01 to 640.00 seconds in 0.01 (1/100) second increments. This allows for finer control when setting flash recycle time. This mode can be used for cameras or flash units.

1. From the main screen press ***/MENU A C** to enter the numeric entry screen
2. Enter the interval or time gap between triggers
3. Press ***/MENU** to proceed to the next screen
4. Enter the count or number of triggers
5. Press ***/MENU** to return to the main screen. The interval will be displayed, and the count will show the number of triggers to be executed
6. Press the **TEST** key or trigger the MultiMAX via Radio to begin Multipop function

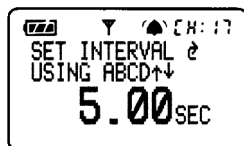

Multi-pop Mode
Set Interval Screen

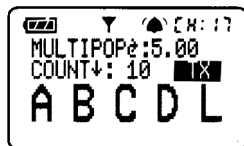

TRANSMIT Unit
5.00 second Multi-pop Interval
10 trigger Count

The following chart is a starting point for calculating how the number of flashes or pops affects F-stops. Since every flash unit is different, use a light meter or other method for more precise calculations.

Number of Pops	Stops	Number of Pops	Stops
1	Add 0 stops	6	Add 2.5 stops
2	Add 1 stop	8	Add 3 stops
3	Add 1.5 stops	12	Add 3.5 stops
4	Add 2 stops	16	Add 4 stops

👁 Contact time is affected by Multipop mode. If the contact time is set greater than the Multipop interval, the contact time will automatically be set to interval time MINUS 0.01 seconds. This means that a remote camera or flash will remain triggered with only a 1/100 second release between contacts. This short released time may not be long enough to re-trigger some cameras or flash units. If this is the case, set the contact time lower.

D: SpeedCycler - TRANSMITTER – */MENU A D

Enables SpeedCycler mode. Use this mode to rapidly cycle through remote flash units and trigger faster than a single flash can recycle by using multiple flash units. It can also be used for triggering remote cameras sequentially.

This mode only works with Quad Triggering channels (17 and higher) and two or more MAX or MultiMAX units (set for RECEIVE mode).

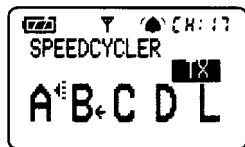

TRANSMIT unit
SpeedCycler Mode
A = triggered with flash confirmation
B = next zone to be triggered

1. From the main screen press */MENU A D to enable SpeedCycler mode on a MultiMAX (set for TRANSMIT mode)
2. Enable two or more remote zones
3. Set each MultiMAX (set for RECEIVE mode) to a different zone
4. Trigger the MultiMAX (set for TRANSMIT mode). The first trigger will fire the first zone selected, the second trigger will fire the next zone selected. The display indicates the next zone to trigger with an arrow. Only the zone just triggered will display proper confirmation

👁 If L is selected then PORT 2 on the MultiMAX (set for TRANSMIT mode) will trigger every time and is not cycled. It will be in sync with each cycled zone.

D: Fast Mode - RECEIVER – */MENU A D

The MultiMAX is designed to sync cameras and flash units at shutter speeds up to 1/250th for most focal plane shutters (35mm) and 1/500th for most leaf shutters. Some camera and flash combinations are capable of fast sync speeds up to 1/1000th. The MultiMAX (set for RECEIVE mode) is capable of operation at these speeds in **Fast Mode**. Check your camera's and flash unit's manuals for the maximum sync speeds allowed by your equipment.

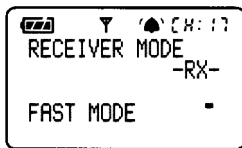



RECEIVE unit
Fast Mode

A MultiMAX (set for RECEIVE mode) in fast mode will show FAST MODE on the display. While in this mode Quad-Trigging and Relay Mode are not available and the **A B C D L** keys perform no function on a RECEIVE unit. A MultiMAX (set for TRANSMIT mode) will trigger RECEIVE units in FAST MODE with any remote zone selected, but will perform confirmation only on zone **A**.

Other Features

Keypad Lock – Hold 

This function prevents inadvertent key presses. Press and hold the  key for 3 seconds to toggle keypad lock on or off.

All keys are locked except  and **TEST**.

While the keypad is locked pressing any of the keys, **A B C D L ▲▼** or ***/MENU** will display the message "KEYPAD LOCKED."

High Voltage Protection

Many electronic cameras can be damaged by high flash sync voltage. Refer to your camera's manual for more information. The MultiMAX protects the camera from high flash sync voltage. The MultiMAX can accept up to 250 volts, but there is only a safe 3.3 volts present at the hot shoe or PORT 1. A camera triggering a MultiMAX (set for TRANSMIT mode) via the hot shoe or PORT 1 only encounters 3.3 volts. This voltage is not MultiMAX battery dependent and will not vary over the life of the batteries.

 See the Hot shoe notes in the **Specifications** section, Page 50 and Page 51, for more information

Relay Mode (RECEIVE Mode Only) – L

In this mode a remote camera's motor drive is triggered by a MultiMAX (set for RECEIVE mode). The MultiMAX then switches to TRANSMIT mode and waits for a sync pulse from the camera. Upon getting the sync pulse from the camera the unit then triggers remote flash units via radio and returns to RECEIVE mode, ready to trigger the camera again. Using this mode it is possible, using only 3 PocketWizard units, to have complete wireless triggering.

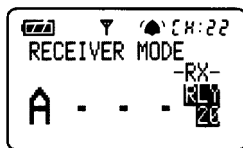

RECEIVE unit in Relay Mode
Receives Channel 22, Zone A
Transmits Channel 20

1. Set a MultiMAX to TRANSMIT mode and select the channel and zones for the remote flash units
2. Set the same MultiMAX to RECEIVE mode and select the channel and zone for the remote camera. Use a different channel than the remote flash units.
3. Press **L** to toggle Relay Mode on. The screen will display RLY XX (where XX is the TRANSMIT channel to be used for relay)
4. Connect the camera's PC terminal to PORT 1 or attach the MultiMAX to the camera's hot shoe
5. Connect the camera's motor drive to PORT 2
6. Trigger the MultiMAX via radio trigger. The camera's motor drive will trigger and the MultiMAX display will change to TRANSMIT mode. The MultiMAX will wait 1.5 seconds for a trigger from the camera. If it gets a trigger in that time it will trigger the remote flash units and return to RECEIVE mode. If it does not get a trigger in that time it will return to RECEIVE mode without triggering the remote units.

Software Version Display – Hold **A** on power up

To check the software version of the MultiMAX without resetting the unit to factory defaults, perform the following

1. Set power switch to OFF
2. Press and hold **A** key
3. Continue to hold **A** and set the power switch to either RECEIVE or TRANSMIT
4. Release **A** key when software version appears
5. Use unit normally

 See the **Reset to Default Factory Settings** section, Page 53, for more information.

Applications of Advanced Functions

The applications below are unique ways to use the advanced functions of the MultiMAX. Many of them require fine-tuning or adjustment to work with different camera equipment. Always perform test exposures to insure reliable results.

Self-Timer or Cable Release

Delays, or Intervalometer and Multipop with a count of 1, can be used as a camera timer for self portraits or as a trigger delay to reduce camera shake. Review **Delay**, **Intervalometer** and **Multipop** sections for more information.

TTL / Auto flash Helper

When using an on-camera TTL flash or Automatic exposure flash with a remote flash there may be situations where you do not want the remote flash to affect the TTL or Auto flash sensor. The on-camera flash can underexpose by quenching early (turning off too soon) because it measured the light from the remote flash. The reverse of this can also be undesirable. If the remote flash is in Automatic mode, it may quench too early because it sensed the light from the on camera flash.

Using Delay mode can help solve this problem. Follow the steps below if using a TTL or Automatic flash attached directly to the camera:

1. Attach the camera's PC terminal to PORT 1 on a MultiMAX (set for TRANSMIT mode)
2. Attach manual or Automatic flash to MultiMAX (set for RECEIVE mode)
3. On the MultiMAX (set for TRANSMIT mode) press ***MENU A A B** to enter the set delay screen
4. Enter in a delay of 0.0020 (1/500)
5. Trigger the camera normally

The on-camera flash will trigger immediately and have enough time to complete its full exposure. After the set delay time the remote flash will trigger. This operation is dependent on camera sync speed and flash duration. The delay time of 0.0020 (1/500) will work with a focal plane shutter (35mm camera) at 1/125 shutter speed and a flash duration not longer than 1/400.

Use the formula below to help calculate your maximum safe shutter speed based on your flash durations.

 Refer to the **Time Conversion Charts** section, Page 55, to convert fractions into decimals for the formula.

1. Add your maximum (longest) flash durations together (decimals, not fractions)
2. Add another 0.002 (focal plane) or 0.001 (leaf shutter) to compensate for shutter travel time
3. On the **Shutter Speed Conversion** chart find the next highest decimal number in the chart. The corresponding shutter speed is the fastest speed you can safely use for this procedure
4. Set the delay time on the MultiMAX (set for TRANSMIT mode) to the same number as your on-camera flash unit's longest flash duration

Programmed sequence shooting

Traveling stroboscopic effects can be achieved by using multiple MultiMAX units (set for RECEIVE mode) in delay mode. Set each RECEIVE unit to a different delay and trigger from a PocketWizard. The sequence is identical on repeat triggers.

Recycle Lockout

Some flash units can be damaged if they are triggered too quickly or before they are fully recharged. This may cause the flash to overheat. Use Multipop Mode to protect the flash by setting a safe recycle lockout time. Follow the steps below:

1. On a MultiMAX (set for RECEIVE mode) press ***/MENU A C**
2. Enter the desired recycle lockout time and press ***/MENU**
3. Enter a count of 1 and press ***/MENU**
4. Attach remote flash to PORT 2

Example: If the lockout time you entered was 3 seconds, then the remote flash could not be triggered more than once every 3 seconds.

Camera Equalization

Equalization, or synchronizing multiple cameras to the same flash, requires precision timing. Even though we perceive camera triggering activity as instantaneous, it is not. Even the flash, which appears to provide light only for an instant, has a time duration (flash duration) that needs to be factored into synchronization calculations.

Every camera has a delay from the time it is triggered until the shutter is fully open. The trigger can originate from either the camera's trigger button or via the motor drive port. This delay is called lag time and it can be different from camera to camera and may even vary between two cameras of the exact same model. If two cameras are triggered at exactly the same time their shutters will be open at different moments. If one camera is attached to a flash, the other camera's shutter will probably not be open at the right moment to capture the flash.

Some cameras are not suitable for equalization. For best equalization a camera must have a consistent lag time. If a camera's lag time varies widely or unpredictably from shot to shot then it may not be possible to synchronize that camera. This is not a flaw of either the camera or the MultiMAX. A varying lag time in a camera is considered acceptable operation for the majority of photographic situations. Cameras are usually designed to respond predictably shot to shot, but are not necessarily or specifically designed to do so with the precision needed for equalization. Many factors can affect a camera's lag time:

- Camera Pre-Trigger status – cameras that have a two stage trigger button (half press “wakes up” the camera, full press triggers the camera) will probably have widely different lag times if triggered while awake versus asleep. Cameras usually have more consistent lag times if they are kept “awake” or Pre-Triggered. The camera will also respond more quickly, but will consume batteries at a faster rate. Pre-Trigger cables are available from PocketWizard for many cameras
- Camera batteries – lag times may begin to drift or slow down as the camera's batteries fade, especially in primarily mechanical cameras. Fresh batteries are recommended for equalization
- Temperature and humidity – as these factors change, the mechanical parts of a camera may move differently thus affecting lag time. A temperature increase may decrease lag time as the camera's internal lubricants are warmed and flow more freely or vice versa
- Horizontal vs vertical orientation – as a camera is moved through these orientations various mechanisms, especially shutters in focal plane cameras, will be affected by gravity making them move differently thus affecting lag time. In general, do not change a camera's orientation during equalization

- Multiple mechanical systems – cameras that have many changeable mechanically interacting parts (film backs, motor drives, lens shutters) are likely to have different lag times with different hardware combinations. A leaf shutter is in the lens so changing lenses on a leaf shutter camera will change lag time. In some medium format cameras having the film back loaded versus unloaded can make a significant difference. For consistent results always use the same components (lens, body, and film back combination for example) each time
- Auto-focus and exposure computers – some auto-focus and exposure systems will introduce widely varying lag times as lens travel and exposure calculations can take unpredictable amounts of time. An electronic camera set to full manual generally provides the most consistent lag times

Lag Time Measurement –

***/MENU A A A L** or ***/MENU A A B L** or
***/MENU A A C L** (RECEIVE units only)

The first step to camera synchronization or equalization is measuring a camera's lag time (triggering delay). The MultiMAX can measure a camera's lag time in most delay modes. Knowing your camera's lag time is critical for camera equalization, but can also be useful in special effects, industrial, commercial, or other photography that requires critical trigger timing.

Using the information above set up your camera for best equalization performance. Attach a MultiMAX (set for RECEIVE mode) to the camera as follows:

1. Place a MultiMAX in the camera's hot shoe or attach a cable from the camera's PC terminal to PORT 1
2. Attach the cable from PORT 2 to the camera's motor drive. If available, use a Pre-Release cable
3. Press ***/MENU A A A** for a standard delay mode where lag times can be measured
4. The screen should display "Set Delay Using **A B C D L ▲ ▼**" and show a numeric value. Press **L**. The unit will trigger the camera and time the delay until a sync pulse is sensed from the hot shoe or lens
5. Press **L** every few seconds to find the fastest and slowest lag times for the camera. Usually the first press of **L** will yield a very different number from later measurements. Ignore the first reading. 5 to 15 lag time measurements after the first one should yield consistent results and give a gauge of the fastest and slowest times
6. Using steps 1 through 5, measure and record the fastest and slowest lag times for each camera you wish to equalize. Subtract the fastest from the slowest and record this number as the camera's lag time variation

 Speed is not the most important factor in camera equalization, consistency is. If a slow camera has extremely consistent lag times it will be a better equalization candidate than a faster but inconsistent camera. The reason why it is important to know the approximate fastest lag time for a camera, especially an inconsistent one, is to calculate margin of error (discussed later in this section).

The amount of drift or lag time inconsistency determines the highest shutter speed at which a camera will reliably equalize. The following table should be used as a starting point for testing purposes only. The numbers in this table are based on a 1/1000th or faster flash duration.

Shutter Speed	Probable maximum safe lag time variation for average focal plane (35mm) camera	Probable maximum safe lag time variation for average leaf shutter camera, F:8.0
1/300	<=0.0003	<=0.0013
1/250	<=0.0010	<=0.0020
1/200	<=0.0020	<=0.0030
1/180	<=0.0025	<=0.0035
1/125	<=0.0050	<=0.0060
1/90	<=0.0080	<=0.0090
1/60	<=0.0137	<=0.0147
1/30	<=0.0303	<=0.0313
1/15	<=0.0637	<=0.0647
1/8	<=0.1220	<=0.1230
1/4	<=0.2470	<=0.2480
1/2	<=0.4970	<=0.4980
1	<=0.9970	<=0.9980
2	<=1.9970	<=1.9980

 Leaf shutters have different shutter blade travel times depending on aperture. A wider aperture takes longer and reduces the amount of variance allowed. A smaller aperture takes less time thereby increasing the allowable variance. (A leaf shutter set to F:4.0, for example, may reduce the variance to the same as a focal plane camera).

👁️ If your camera's maximum sync speed is slower than the number listed then you must use the slower sync speed. Camera equalization does not give a camera faster sync speeds than the camera is designed to handle.

For all shutters it can be assumed that a camera with faster external flash sync speeds (X sync) will have faster shutter travel than cameras with slower X sync speeds.

Faster shutter travel times increase the allowable variance. The table above is based on the following shutter travel times:

- Focal Plane (35mm) – 1/1000 (0.0010) to open, 1/1000 to close
- Leaf shutter at f: 8.0 – 1/2000 (0.0005) to open, 1/2000 to close

If a flash is generating light while the shutter is moving then you will see the shutter in the exposure for focal plane shutters. You will see a loss in F stop exposure using a leaf shutter if the flash is generating light as the shutter aperture opens or closes.

A variable flash duration will also affect these calculations. A slow flash is visible for longer and more likely to affect exposure while the shutter is in motion. A short flash duration reduces the likelihood of timing variances affecting the exposure.

It is difficult to measure a shutter's travel time or a flash units duration and it usually requires extremely expensive test equipment. Some electronic flash manufacturers print their flash durations in their manual. The best method for understanding your equipment's equalization capabilities is to shoot many test exposures over a range of settings.

Recommend Equipment for the best results

- Consistent lag time cameras
- Cameras with ast sync speeds
- Electronic flash equipment with short flash duration

One Unit Equalization

To equalize two cameras and one flash at 1/125 with one MultiMAX, follow these steps:

1. Set the MultiMAX to RECEIVE mode
2. Measure lag times of cameras as described and record the fastest lag for each
3. Determine which camera is faster and which is slower overall
4. Determine the delay time
 - a. If the slow camera is more consistent use this formula:
 - i. Slower Camera's Fastest Lag Time MINUS Faster Camera's Fastest Lag Time **MINUS** 0.0025 {calculated safety margin}
 - b. If the fast camera is more consistent use this formula:
 - i. Slower Camera's Fastest Lag Time MINUS Faster Camera's Fastest Lag Time **PLUS** 0.0025 {calculated safety margin}
5. Press ***/MENU A A B** then enter the calculated delay time from Step 4
6. Attach the slower camera's motor drive to PORT 1
7. Attach the faster camera's motor drive to PORT 2
8. Attach the flash to the more consistent (smallest lag time variance) camera
9. Trigger the RECEIVE unit either from the **TEST** key or from a TRANSMIT unit

Two Unit Equalization

Two Unit Equalization is basically the same as above, but allows the two cameras to be more remote. The difference in calculations compensates for radio trigger delay.

1. Set one MultiMAX to RECEIVE mode, and one to TRANSMIT mode
2. Using the RECEIVE unit, measure the lag times of each camera as described above and record the fastest lag for each
3. Determine which camera is faster and which is slower overall
4. Determine the delay time
 1. If the slow camera is more consistent use this formula:
 1. Slower Camera's Fastest Lag Time MINUS Faster Camera's Fastest Lag Time **MINUS** 0.0030 {calculated safety margin}
 2. If the fast camera is more consistent use this formula:
 1. Slower Camera's Fastest Lag Time MINUS Faster Camera's Fastest Lag Time **PLUS** 0.0020 {calculated safety margin}
5. On the RECEIVE unit press ***/MENU A A A**. Enter the time from Step 4
6. Attach the slower camera's motor drive to PORT 2 on the TRANSMIT unit. Do not leave the MultiMAX (set for TRANSMIT mode) in the hot shoe or have the PC terminal attached to PORT 1 as this may cause a looping or lock-up situation
7. Attach the faster camera's motor drive to either PORT on the RECEIVE unit
8. Attach the flash to the more consistent (smallest lag time variance) camera
9. Trigger the system from the TRANSMIT unit's **TEST** key

If using both MultiMAX units as RECEIVE units being triggered by any PocketWizard Transmitter follow these steps:

1. Set both units to RECEIVE mode
2. Measure lag times of cameras as previously described and record the fastest lag for each
3. Determine which camera is faster and which is slower overall
4. Determine the delay time
 - a. If the slow camera is more consistent use this formula:
 - i. Slower Camera's Fastest Lag Time MINUS Faster Camera's Fastest Lag Time **MINUS** 0.0025 {calculated safety margin}
 - b. If the fast camera is more consistent use this formula:
 - i. Slower Camera's Fastest Lag Time MINUS Faster Camera's Fastest Lag Time **PLUS** 0.0025 {calculated safety margin}
5. Attach the slower camera's motor drive to either PORT on the first unit
6. Attach the faster camera's motor drive to either PORT on the second unit
7. On the second unit press ***/MENU A A A**, then enter the calculated delay time from Step 4
8. Make sure there is no delay being performed on the first unit
9. Attach the flash to the more consistent (smallest lag time variance) camera
10. Trigger the system from a TRANSMIT unit's **TEST** key

 If using 4 or more units you may find it easier to use the built-in Equalize mode. See the **Equalize** section, Page 35, for more information.

Equalization Adjustments

With all the variable factors above it may seem that performing the math necessary for equalization is daunting. Here are some techniques for fine-tuning or adjusting equalization times without using specific math:

On some 35mm cameras you can gauge timing without using film. If your camera allows triggering with the film back open you can verify synchronization visually.

1. Perform the steps above to get basic equalization started
2. Point the flash at a blank wall
3. On the camera NOT attached to the flash, set the shutter speed to 1/60
4. Open that camera's back
5. Point the camera at the same wall as the flash

6. As the camera and flash are being triggered look through the shutter plane through the lens at the light from the flash hitting the wall. CAUTION: MAKE SURE the flash is set to a comfortable level for your eyes!
7. Note the shape of the light burst. If it is a perfect bright circle then the camera is in sync. If the circle is dark or has a hard line running along one edge then the camera is not in sync. The hard line is the shutter in motion while the flash is still generating light
8. Adjust the shutter speed up or down until you see a perfect circle

 The delay time setting screen is instantly active. While in numeric entry mode you can adjust the delay up or down and the displayed value will be executed on the next trigger. Using the "through-the-back" method above or by shooting film, Polaroid, or digital you can adjust the delay and view the results to more suit your specific camera's timings.

The mathematical formulas used thus far are designed for equalizing at 1/125. The final offset number (0.0025 for example) may need to be adjusted when attempting to equalize at faster shutter speeds or slower ones with wide lag variation cameras. The offset number tries to move the flash burst to the middle of the exposure to compensate for drifting lag time. Experiment with different offsets to fine tune your shutter speed, flash duration, and camera timing combinations. Too long or short of an offset and you limit a camera's ability to get the exposure if the lag drifts, even by a small amount.

 Visit <http://www.pocketwizard.com/> for more information on camera specific equalization techniques. As more information becomes available it will be posted there.

Technical Information

Specifications

Weight:	5.4 ounces with alkaline batteries
Dimensions:	1.4 inches deep x 2.1 inches wide x 4.0 inches tall (body only) Flexible antenna = 2.4 inches tall. 0.3 inches in diameter
Batteries:	2 x AA (IEC:LR6), 1.5 V batteries, alkaline recommended Read the Getting Started section, Page 13, for more information
AC Adapter Jack:	3 VDC unregulated, 0.3 A (300 milliamp) or higher 4.5 VDC regulated, 0.2 A (200 milliamp) or higher, (recommended) Polarity = center positive, outside negative Male plug specifications: 1.3mm ID, 3.4mm OD, 1cm long

Input / Output Ports:

Size	3.5mm (1/8") mono miniphone
Maximum Input Voltage	250 VDC
PORT 1 current handling	0.5 A (½ Amp), current limited
PORT 2 current handling	4.0 A for 0.0002 seconds (1/50000 second or 20 microseconds) 0.25 A (1/4 Amp or 250 milliamp) continuous, current limited
PORT 1 polarity	tip positive, non-reversible
PORT 2 polarity	tip positive, reversible
PORT 1 and Hot Shoe Voltage present	3.3 VDC, 0.001 A (1/1000 Amp or 1 milliamp), regulated
PORT 1 and Hot Shoe triggering threshold	< 2.2 V
PORT 1 and Hot Shoe holding current	0.0005 A (1/2000 Amp or 50 microamps)

HOT SHOE NOTE #1: PORT 1 and the hot shoe are electrically connected together. A device attached to PORT 1 will trigger when the TRANSMIT unit is triggered by the hot shoe. This is not controllable by the L key. While the device may trigger in sync with the shutter, it will not be controlled by the MultiMAX. If the device is a high voltage flash unit then the MultiMAX does not provide voltage protection to the camera in this situation. For normal operation do not use PORT 1 to trigger a high voltage flash on a TRANSMIT unit unless nothing is attached to the hot shoe.

HOT SHOE NOTE #2: Some cameras may exhibit undesirable behavior if the RECEIVE unit is mounted in the camera hot shoe when that camera is being fired remotely. Some cameras' hot shoe and motor drive contacts may share some connections. This can cause the camera to lock up or stop operating normally. If your camera does not function properly in this mode then remove the unit from the camera's hot shoe.

Radio Information

- Transmit Output Power: 0.001 watt (1/1000 of a watt or 1 milliwatt)
- Typical Transmitter Output Duration: 0.0005 seconds (1/2000 second or 50 microseconds)
- Bandwidth: Narrowband, 70KHz TRANSMIT, 230KHz RECEIVE

PocketWizard Radio Frequencies:

Channel	Frequency	Unit	Digital Code
1 through 16	344.04 MHz	Classic, Plus, MAX, and MultiMAX	16 Bit
17	346.50 MHz	MultiMAX and MAX only	24 Bit (20 Bit in FAST MODE)
18	347.00 MHz		
19	347.50 MHz		
20	348.00 MHz		
21	348.50 MHz		
22	349.00 MHz		
23	349.50 MHz		
24	350.00 MHz		
25	350.50 MHz		
26	351.00 MHz		
27	351.50 MHz		
28	352.00 MHz		
29	352.50 MHz		
30	353.00 MHz		
31	353.50 MHz		
32	354.00 MHz		

Maximum and Minimum Settings

The following table details the maximum and minimum values allowed for each numeric entry setting available in the MultiMAX.

Setting	Maximum	Minimum
Contact Time	640.00 seconds or 10 minutes, 40 seconds	.01 seconds
Delay Time	6.4000 seconds	.0001 seconds (add 0.0005 to displayed value for RECEIVE units triggered via radio)
Interval (Intervalometer mode)	64000 seconds or 17 hours, 46 minutes, 40 seconds	1 second
Interval (Multipop mode)	640.00 seconds or 10 minutes, 40 seconds	.01 seconds
Count (for Load Count or Intervalometer / Multipop)	9999	0

Intervalometer maximum time is 64000 second intervals for 9999 triggers or 177,760 hours (7,406 days, 16 hours) or approximately 20 years, 3 months, 11 and 2/3 days.

Saved Settings

Settings are saved whenever the ***/MENU** key is pressed. The following settings are always RESET on normal power down:

- Counter (resets to saved load value if count is **0**, resets to 0 if count is **m**)
- Rear Curtain Sync (fraction display returns to 1/1)
- Any dynamic numeric entry screen displayed as unit is powered off will default to its previous saved setting. The screens affected are : Load counter, Delay time, and Interval (Multipop or Intervalometer)

The following settings are saved on power down:

Channel	Beep Mode	Delay Time
Zone	Contact Time	Interval
Relay Mode	Load Count	Advanced Mode
Fast Mode	Counter Mode	

Troubleshooting

When in doubt !

Many issues can be resolved by powering the unit off and then back on again or by resetting to factory default settings. Before proceeding to any other troubleshooting procedure follow these steps:

1. Set power to OFF
2. Wait 10 seconds or until display completely blanks
3. Set power to RECEIVE or TRANSMIT

Reset to Default Factory Settings

1. Set power switch to OFF
2. Press and hold **C** key
3. Continue to hold **C** and set the power switch to either RECEIVE or TRANSMIT
4. Release **C** key when CLEAR/RESET message appears

Default factory settings are as follows:

Channel	17	Display Contrast	Medium
Transmitter Zones	A B C D L all enabled	Delay Time	0.0100 sec
Receiver Zone	A	Equalize Calculated Time	0.1500 sec
Relay Mode	OFF	Interval Time	100 sec
Operating mode	NORMAL	Multipop Time	1.00 sec
Contact Time	0.12 sec	Counter Mode	OFF
Beep Mode	All	Counter Load	36
Fast Mode	OFF		

 The following indicators may operate erratically during reset, but will return to normal operation when reset completes: Battery Level, Frequency Lock, Beep Mode, and Channel.

 The CLEAR/RESET message also displays the software version installed in the unit. To view just the software version without losing settings refer to the **Software Version Display** section, Page 40, for more information.

Radio Performance

The MultiMAX is an advanced digital radio system. Its true digital technology guarantees optimum interference rejection while maintaining high performance. As with all radio devices (cell phones, walkie talkies, cordless sound systems) there are some situations where performance may be degraded by outside factors. For maximum radio performance for the MultiMAX, or any radio device, follow the guidelines below:

- Keep antennas parallel. The antenna radiation and reception pattern is designed for best performance in this orientation.
- While not required for operation, maintaining line of sight between TRANSMIT and RECEIVE units will give best performance. Radio can work through objects, but its range may be reduced.
- Mount RECEIVE units away from metal objects. Some metal objects can act as an antenna. The radio noise in an area may be conducted by the metal and can reduce the range of a RECEIVE unit which works harder to reject extra noise. Moving a RECEIVE unit a few inches away from metal, or mounting the unit such that the antenna is away from or above the metal, will eliminate this issue.
- Mount units away from water. Water absorbs radio energy. If shooting around water-filled objects try to maintain line of sight between units whenever possible. Sources of water that might affect a unit's range are:
 - Trees – if shooting in a large forest with many trees, try to maintain line of sight
 - People – mount RECEIVE units above the heads of large crowds and use TRANSMIT units in the camera's hot shoe whenever possible
 - Rain – Heavy downpours may affect range
- Large metal and concrete structures affect radio. Attempting to trigger through large metal or concrete objects or buildings will result in a reduction in range. Try to mount RECEIVE units in windows for best performance when shooting architecture.
- Flash pack mounting – mount the RECEIVE unit with the antenna completely above the top of the body of the flash unit. Keep the antenna away from the metal in a flash unit

If you are experiencing range problems and you have followed the guidelines above, try moving the RECEIVE unit a few inches in any direction. Radio reflections from surrounding objects can sometimes cause nodes, or "dead spots." Relocating the RECEIVE unit just a few inches from these spots can dramatically improve range.

 Visit <http://www.pocketwizard.com/> for more troubleshooting information. As more information becomes available it will be posted there. Be sure to check out the Frequently Asked Questions section on the website.

Time Conversion Charts

Fractions to Decimal:

Here are some common photographic fractions in decimal values. All numbers are rounded to the nearest .0001 or 1/10,000th.

 These times are not Rear Curtain Sync times. These are precision numbers. Rear Curtain Sync numbers are always less than the exact conversions. Refer to the **Rear Curtain** section, Page 33, for more information.

Fraction	Decimal	Fraction	Decimal
1/2	0.5 seconds	1/180	0.0056 seconds
1/4	0.25 seconds	1/200	0.005 seconds
1/8	0.125 seconds	1/250	0.004 seconds
1/15	0.0667 seconds	1/500	0.002 seconds
1/30	0.0333 seconds	1/1000	0.001 seconds
1/60	0.0167 seconds	1/2000	0.0005 seconds
1/90	0.0111 seconds	1/4000	0.0003 seconds
1/125	0.008 seconds	1/8000	0.0001 seconds

Seconds to Minutes and Hours:

Use the following table to help calculate long intervals or delays.

Seconds	Minutes	Seconds	Hours
60 seconds	1 minute	3600 seconds	1 hour
120 seconds	2 minutes	7200 seconds	2 hours
180 seconds	3 minutes	10800 seconds	3 hours
240 seconds	4 minutes	14400 seconds	4 hours
300 seconds	5 minutes	18000 seconds	5 hours
600 seconds	10 minutes	36000 seconds	10 hours
1200 seconds	20 minutes		
1800 seconds	30 minutes		

